

# SOLARKING

## Solar Roof Exhaust Fan Metal Roof Installation Instructions

### STEP 1

Study figure 1 to assess how many SolarKing fans you require for your home or business.

### Step 2

To work out where to position the fan you need to take into consideration any afternoon shade on the roof during the warmer months (Tip: Shade will effect the performance of the solar fan). The position should also allow the solar panel to receive sun from the North and West during the warmer months.

### STEP 3

Slide the top edge of the flashing up under the ridge capping of the roof (remove 2 ridge capping screws to do this) as per Figure 2. It is important to position the flashing is not covering any roofing screws, the roofing screws running from the top to the bottom of the roof are where the rafters are located. Once positioned mark a circle on the inside edge of the flashing.

### STEP 4

Following the circle marked on the roof cut the roof as per figure 3 using a metal bladed saw or tin snips. If there is any foil under the metal sheets cut a cross in the foil and fold back the corners. Tip: Take care not to cut into any battens/rafters under the roof sheet when cutting.

### STEP 5

Slide the flashing back up under the roof capping and refit the 2 ridge capping screws through the flashing and bend the edges of the flashing down on the left and right sides of the flashing to create a tight fit with the roof. Then using tin snips to cut notches in the bottom of the flashing to suit the corrugations of the roof and bend the notches down. Then silicon the underside of the edges and the outside of the edges and the underside and outside of the bottom section of the flashing. Note: Don't silicon the valleys on the bottom of the flashing.

### Step 6

As per figure 4 use up a minimum of 8 (but up to 12) tech or roof screws with rubber seals along the left, right and bottom of the flashing to secure to the roof. Note: Tech screws and roofing screws are not included.

Figure 1

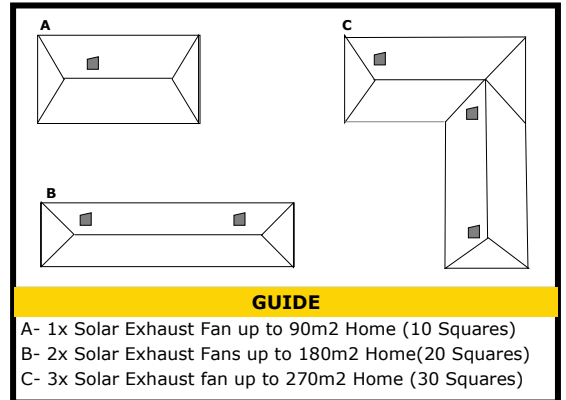

Figure 2

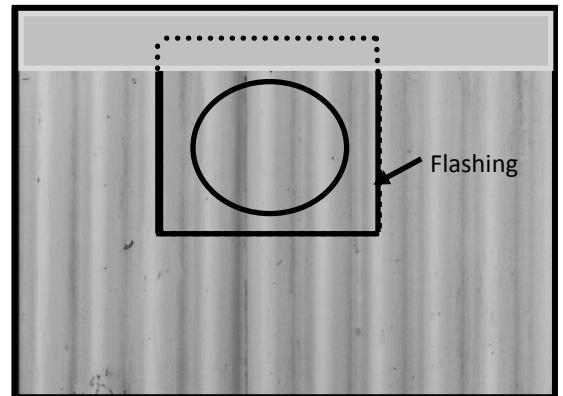

Figure 3

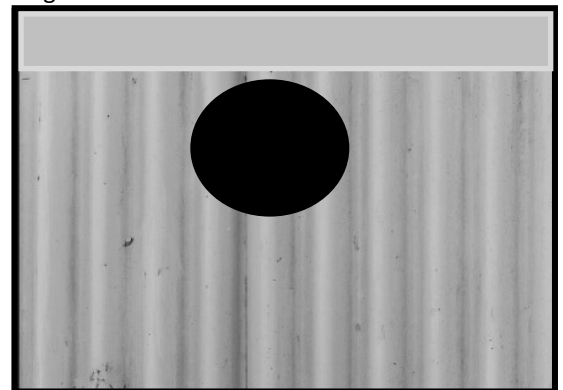
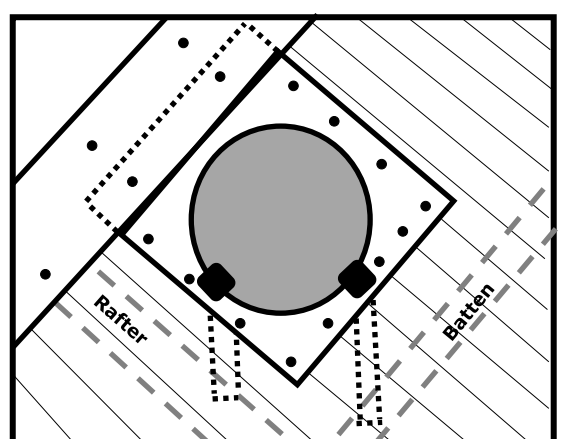

Figure 4



# SOLARKING

## Solar Roof Exhaust Fan Metal Roof Installation Instructions

### STEP 7

As per figure 4 fit a minimum of 1 rafter/batten strap (2 supplied). The strap folds over the circular ridge on the flashing and can either be screwed or nailed through the strap.

### STEP 8

Place the main body of the fan over the flashing as per figure 5. Turn the main body of the fan left or right to suit the direction required for the solar panel (Tip: Aim between North and West to best suit the sun in warmer months)

### STEP 9

As per figure 6 using a powered screw driver, screw at least 4 small tech screws through the pre-drilled holes in the fan main body through into the flashing. (Tip: You may not be able to get the top tech screw in place as the angle of the roof may prevent this, in this case you can simply screw the tech screw into another section where the main body is over the flashing)

### Step 10

As per figure 7 you can now adjust the angle of the solar panel to receive maximum sun during the mid afternoon in the warmer months. As the pitch of many roofs in parts of Australia are already at a good angle for the summer time sun you may just be able to leave the panel in the down position as it is supplied from the factory, no need to do anything. To adjust the angle of the solar panels up just adjust the 2 arms to the correct angle and tighten the screws.

### Options

Fitting under the eave vents as per figure 8 to the side of the house that is cool in the afternoon will allow the cooler outside air to be drawn into the roof space. These are especially required when the roof has foil under the tiles, but regardless eave vents will improve airflow.

### Parts Included in this kit:

1x Solar Fan, 1x Flexible Flashing, 5x Tech Screws, 2x Rafter/batten Straps

Figure 5

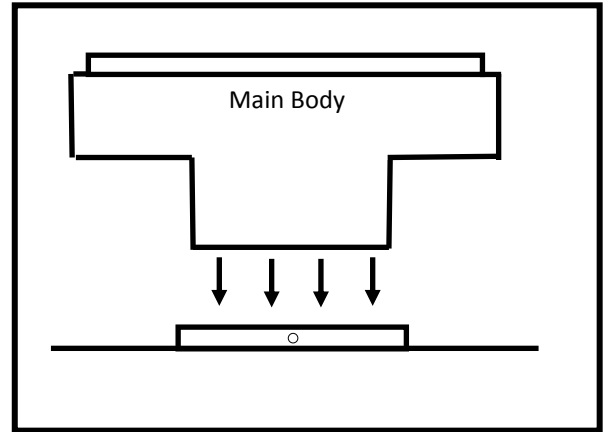

Figure 6

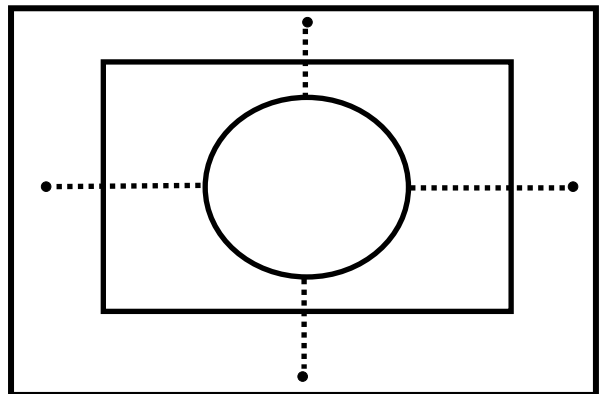

Figure 7

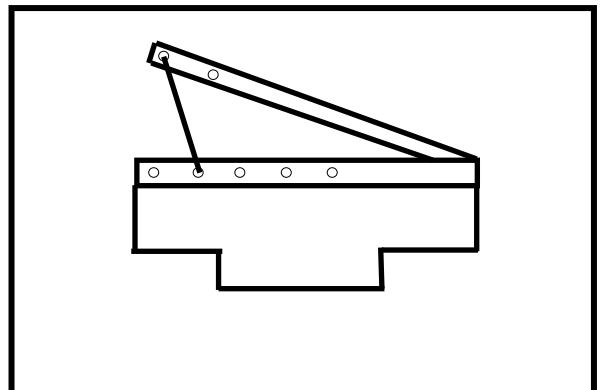

Figure 8

